

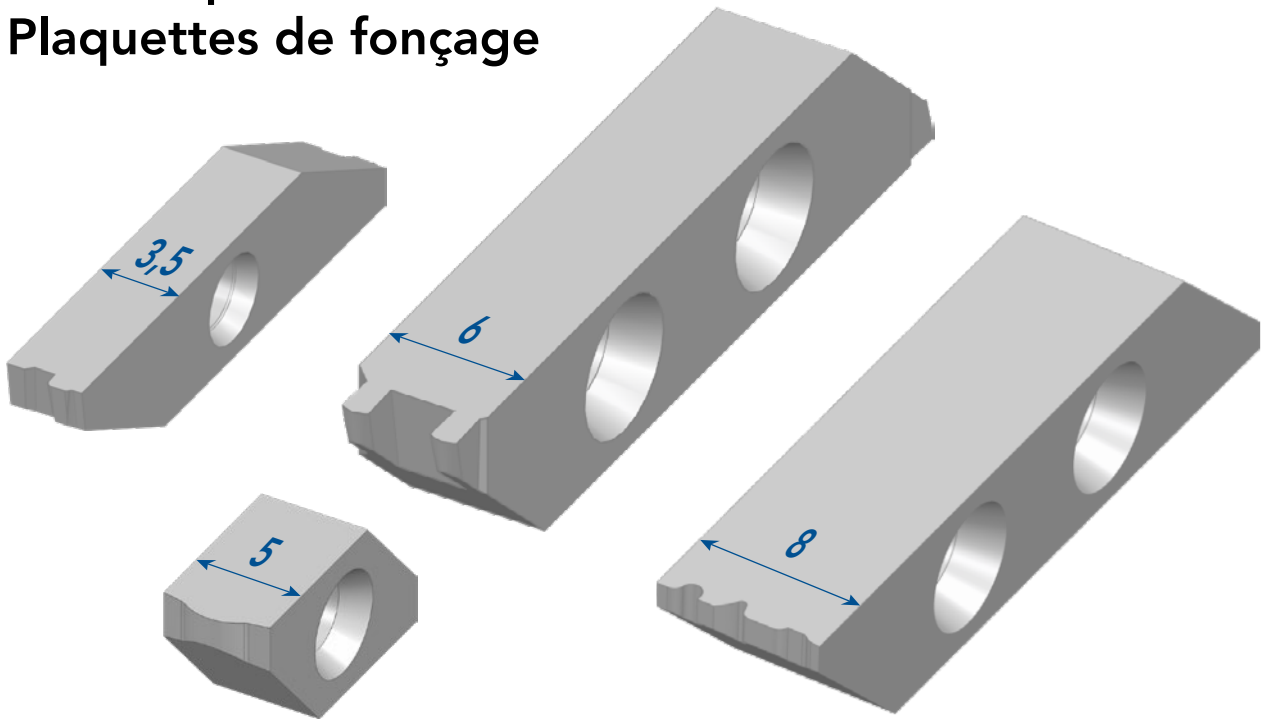



Grooving inserts Einstechplatten Plaquettes de fonçage





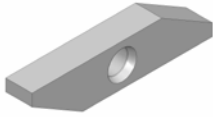
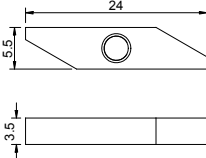

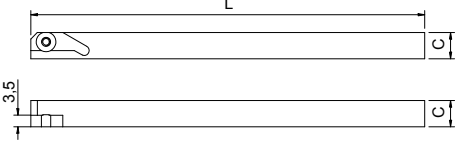
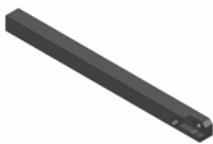
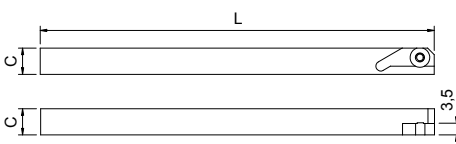



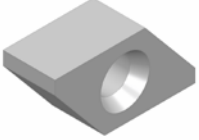
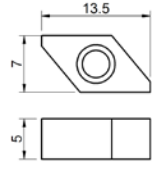

- Fully ground to your specification (examples of profiles illustrated).
- 4 different widths of blank inserts available.
- Double ended.
- Coated inserts.

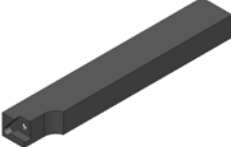
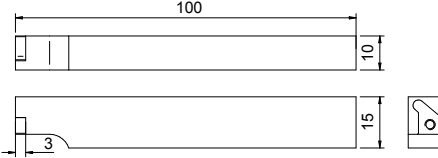
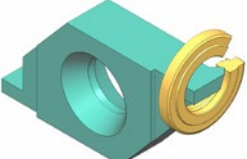



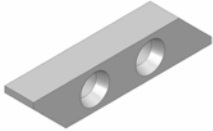
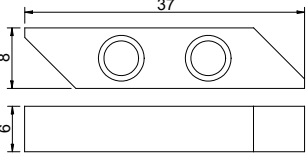

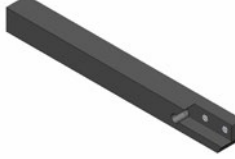
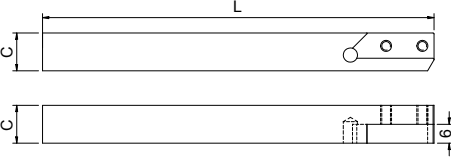
- Realisierung nach kundenspezifischen Angaben.
(Bilder : Realisierbare Profilbeispiele)
- 4 verschiedene Breiten der Wendepplattenrohlinge verfügbar.
- 2 Schneidkanten.
- Beschichtete Wendepplatte.

- Réalisation de profils personnalisés (ci-dessus : exemples de profils réalisables).
- 4 largeurs différentes d'ébauches disponibles.
- 2 arêtes de coupe.
- Plaquette revêtue.

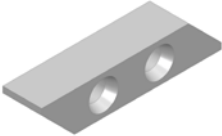
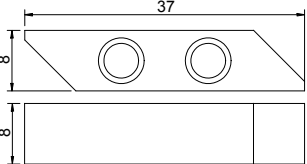
040R/L3,5K18 3,5 mm	Blank insert 3,5 mm (left and right) Rohling 3,5 mm (links und rechts) Plaquette ébauche 3,5 mm (gauche et droite)	Article nr. Artikel Nr. N° Article		
		040R/L3,5K18		
0xxR	Right tool holder for 3,5 mm inserts Werkzeughalter rechts für 3,5 mm Wendeplatten Porte-outil à droite pour plaquettes 3,5 mm	Section C Querschnitt C Section C	Length L Länge L Longueur L	Article nr. Artikel Nr. N° Article
		7 x 7 8 x 8 10 x 10 12 x 12 16 x 16 20 x 20	120 120 120 120 100 100	007R 008R 010R 012R 016R 020R
0xxL	Left tool holder for 3,5 mm inserts Werkzeughalter links für 3,5 mm Wendeplatten Porte-outil à gauche pour plaquettes 3,5 mm	Section C Querschnitt C Section C	Length L Länge L Longueur L	Article nr. Artikel Nr. N° Article
		7 x 7 8 x 8 10 x 10 12 x 12 16 x 16 20 x 20	140 140 120 120 100 100	007L 008L 010L 012L 016L 020L
001-2	Screw for tool holders 0xxR and 0xxL Schraube für Werkzeughalter 0xxR und 0xxL Vis pour porte-outils 0xxR et 0xxL	Article nr. Artikel Nr. N° Article		
	M2,5 x 7,5	001-2		

340R5 5 mm	Blank insert 5 mm (left and right) Rohling 5 mm (links und rechts) Plaquette ébauche 5 mm (gauche et droite)	Article nr. Artikel Nr. N° Article		
		340R5		
38xxR	Right tool holder for 5 mm inserts Werkzeughalter rechts für 5 mm Wendeplatten Porte-outil à droite pour plaquettes 5 mm	Section C Querschnitt C Section C	Length L Länge L Longueur L	Article nr. Artikel Nr. N° Article
		10 x 10	100	3810R
		12 x 12	100	3812R
		16 x 16	100	3816R
100-3	Screw for tool holder 38xxR Schraube für Werkzeughalter 38xxR Vis pour porte-outil 38xxR	Article nr. Artikel Nr. N° Article		
	M3,0 x 10	100-3		
3xx15RF	Frontal tool holder for 3 mm inserts Frontalwerkzeughalter für 3 mm Wendeplatten Porte-outil frontal pour plaquettes 3 mm	Section C x D Querschnitt C x D Section C x D	Length L Länge L Longueur L	Article nr. Artikel Nr. N° Article
		10 x 15	100	31015RF
		12 x 15	100	31215RF
		<p>Please contact us for further information about 3 mm inserts. Bitte kontaktieren Sie uns für weitere Informationen zu 3 mm Wendeplatten. Veuillez nous contacter pour plus d'informations sur les plaquettes de 3 mm.</p> 		
001-3	Screw for tool holder 3xx15RF Schraube für Werkzeughalter 3xx15RF Vis pour porte-outil 3xx15RF	Article nr. Artikel Nr. N° Article		
	M3,0 x 6,5	001-3		

715R/L-6 6 mm	Blank insert 6 mm (left and right) Rohling 6 mm (links und rechts) Plaquette ébauche 6 mm (gauche et droite)	Article nr. Artikel Nr. N° Article		
		715R/L-6		
100BH3-1xxR-6	Right tool holder for 6 mm inserts Werkzeughalter rechts für 6 mm Wendepplatten Porte-outil à droite pour plaquettes 6 mm	Section C Querschnitt C Section C	Length L Länge L Longueur L	Article nr. Artikel Nr. N° Article
		10 x 10	120	100BH3-110R-6
		12 x 12	120	100BH3-112R-6
		16 x 16	120	100BH3-116R-6
		20 x 20	120	100BH3-120R-6
100BH3-1xxL-6	Left tool holder for 6 mm inserts Werkzeughalter links für 6 mm Wendepplatten Porte-outil à gauche pour plaquettes 6 mm	Section C Querschnitt C Section C	Length L Länge L Longueur L	Article nr. Artikel Nr. N° Article
		12 x 12	120	100BH3-112L-6
		16 x 16	120	100BH3-116L-6
001-10	Screw for tool holders 100BH3-1xxR-6 and 100BH3-1xxL-6 Schraube für Werkzeughalter 100BH3-1xxR-6 und 100BH3-1xxL-6 Vis pour porte-outils 100BH3-1xxR-6 et 100BH3-1xxL-6	Article nr. Artikel Nr. N° Article		
	M3,5 x 11,5	001-10		

715R/L-8 8 mm	Blank insert 8 mm (left and right) Rohling 8 mm (links und rechts) Plaquette ébauche 8 mm (gauche et droite)	Article nr. Artikel Nr. N° Article								
		715R/L-8 <div style="float: right; background-color: yellow; padding: 5px; border: 1px solid black;"> New New Nouveau </div>								
100BH3-1xxR-8	Right tool holder for 8 mm inserts Werkzeughalter rechts für 8 mm Wendepplatten Porte-outil à droite pour plaquettes 8 mm	Section C Querschnitt C Section C	Length L Länge L Longueur L	Article nr. Artikel Nr. N° Article						
		<table border="1" style="width: 100%; border-collapse: collapse;"> <tr> <td style="width: 15%;">12 x 12</td> <td style="width: 15%;">120</td> <td style="width: 20%;">100BH3-112R-8</td> </tr> <tr> <td>16 x 16</td> <td>120</td> <td>100BH3-116R-8</td> </tr> </table>			12 x 12	120	100BH3-112R-8	16 x 16	120	100BH3-116R-8
12 x 12	120	100BH3-112R-8								
16 x 16	120	100BH3-116R-8								
100BH3-1xxL-8	Left tool holder for 8 mm inserts Werkzeughalter links für 8 mm Wendepplatten Porte-outil à gauche pour plaquettes 8 mm	Section C Querschnitt C Section C	Length L Länge L Longueur L	Article nr. Artikel Nr. N° Article						
		<table border="1" style="width: 100%; border-collapse: collapse;"> <tr> <td style="width: 15%;">12 x 12</td> <td style="width: 15%;">120</td> <td style="width: 20%;">100BH3-112L-8</td> </tr> <tr> <td>16 x 16</td> <td>120</td> <td>100BH3-116L-8</td> </tr> </table>			12 x 12	120	100BH3-112L-8	16 x 16	120	100BH3-116L-8
12 x 12	120	100BH3-112L-8								
16 x 16	120	100BH3-116L-8								
001-10	Screw for tool holders 100BH3-1xxR-8 and 100BH3-1xxL-8 Schraube für Werkzeughalter 100BH3-1xxR-8 und 100BH3-1xxL-8 Vis pour porte-outils 100BH3-1xxR-8 et 100BH3-1xxL-8		Article nr. Artikel Nr. N° Article							
	M3,5 x 11,5		001-10							



Represented by Vertreten durch Représenté par

