

Machining tool holder

Drehhalter

Porte-outil machine

Grinding tool holder

Schleifwerkzeughalter

Porte-outil d'affûtage

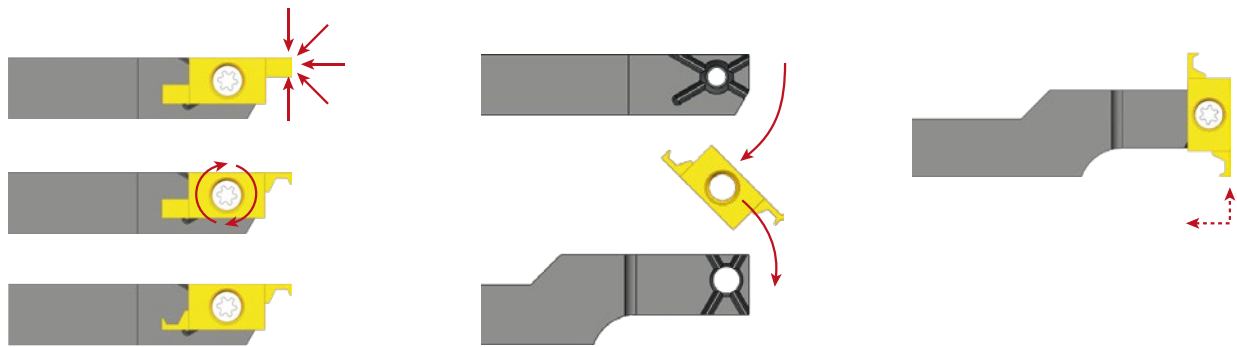

1. Sharpening of the 2 cutting edges of the pre-rectified blank on the grinding tool holder.

1. Einfaches Schleifen des Rohlings auf dem Schleifwerkzeughalter.

1. Meulage sans encombre des 2 arêtes de coupe de la plaquette ébauche pré-rectifiée sur le porte-outil d'affûtage.

2. Transfer of the grinded blank on the machining tool holder.

2. Wechseln der Patte vom Schleifhalter auf den Drehhalter.

2. Transfert de la plaquette affûtée sur le porte-outil d'usinage.

3. Use of the insert set up on the machining tool holder same as a standard hook tool holder.

3. Verwendung des geschliffenen Rohlings wie ein Standard-Hakenstahl.

3. Utilisation de la plaquette montée sur le porte-outil d'usinage comme un porte-outil à crochet standard.

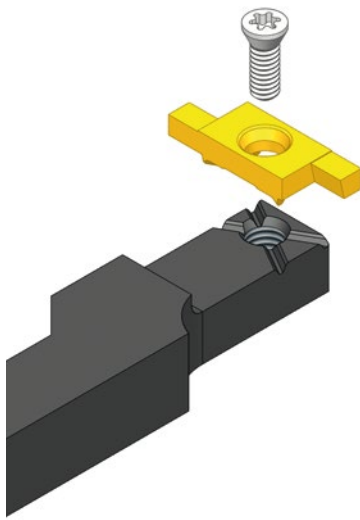

«X-Centering» fixing system

- Positioning in all axes.
- The screw is free of all radial stress.
- Insert turning without having to remove the screw.
- Two cutting edges available.

Befestigungssystem «X-Centering»

- Platzierung in allen Achsen.
- Keine radialen Spannungen.
- Umdrehen der Schneidplatte ohne Entfernen der Schraube.
- Zwei verfügbare Schneidkanten.



Système de fixation «X-Centering»

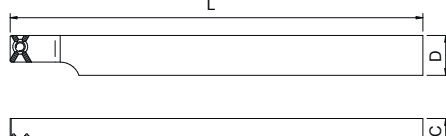

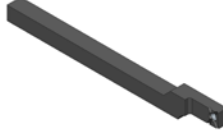
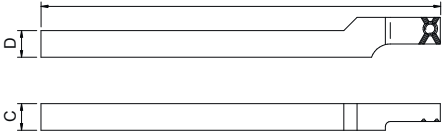

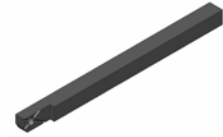
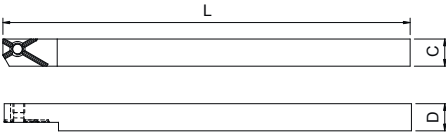
- Centrage dans tous les axes.
- La vis est libre de toute tension radiale.
- Retournement de la plaquette sans enlever la vis.
- Deux arêtes de coupe disponibles.

4xxxxR	Right machining tool holder Rechter Bearbeitungswerkzeughalter Porte-outil machine à droite	Section CxD Querschnitt CxD Section CxD	Length L Länge L Longueur L	Article nr. Artikel Nr. N° Article
		8 x 12	120	40812R
		10 x 12	120	41012R
		12 x 15	120	41215R
		16 x 16	120	41616R

4xxxxL	Left machining tool holder Linker Bearbeitungswerkzeughalter Porte-outil machine à gauche	Section CxD Querschnitt CxD Section CxD	Length L Länge L Longueur L	Article nr. Artikel Nr. N° Article
		7 x 7	120	40707L
		8 x 8	120	40808L
		12 x 12	120	41212L

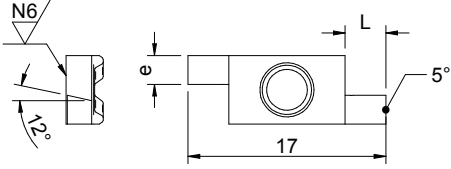
4xxR	Right grinding tool holder Rechter Schleifwerkzeughalter Porte-outil d'affûtage à droite	Section CxD Querschnitt CxD Section CxD	Length L Länge L Longueur L	Article nr. Artikel Nr. N° Article
		8 x 8	120	408R
		10 x 10	120	410R
		12 x 12	120	412R

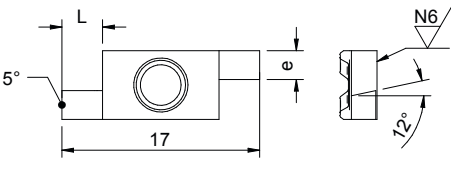
4xxL	Left grinding tool holder Linker Schleifwerkzeughalter Porte-outil d'affûtage à gauche	Section CxD Querschnitt CxD Section CxD	Length L Länge L Longueur L	Article nr. Artikel Nr. N° Article
		8 x 8	120	408L
		10 x 10	120	410L
		12 x 12	120	412L

421R	Right blank insert Rechter Wendepattenrohling Plaquette ébauche à droite	<table border="1"> <thead> <tr> <th>e</th> <th>L</th> <th>Article nr. Artikel Nr. N° Article</th> <th>K10</th> <th>BI40</th> </tr> </thead> <tbody> <tr> <td>1,5</td> <td>3,5</td> <td>421R1,5</td> <td>✓</td> <td>✓</td> </tr> <tr> <td>2,5</td> <td>3,5</td> <td>421R2,5</td> <td>✓</td> <td>✓</td> </tr> </tbody> </table>	e	L	Article nr. Artikel Nr. N° Article	K10	BI40	1,5	3,5	421R1,5	✓	✓	2,5	3,5	421R2,5	✓	✓
e	L	Article nr. Artikel Nr. N° Article	K10	BI40													
1,5	3,5	421R1,5	✓	✓													
2,5	3,5	421R2,5	✓	✓													
																	
421L	Left blank insert Linker Wendepattenrohling Plaquette ébauche à gauche	<table border="1"> <thead> <tr> <th>e</th> <th>L</th> <th>Article nr. Artikel Nr. N° Article</th> <th>K10</th> <th>BI40</th> </tr> </thead> <tbody> <tr> <td>1,5</td> <td>3,5</td> <td>421L1,5</td> <td>✓</td> <td>✓</td> </tr> <tr> <td>2,5</td> <td>3,5</td> <td>421L2,5</td> <td>✓</td> <td>✓</td> </tr> </tbody> </table>	e	L	Article nr. Artikel Nr. N° Article	K10	BI40	1,5	3,5	421L1,5	✓	✓	2,5	3,5	421L2,5	✓	✓
e	L	Article nr. Artikel Nr. N° Article	K10	BI40													
1,5	3,5	421L1,5	✓	✓													
2,5	3,5	421L2,5	✓	✓													
																	
001-3	Key Schlüssel Clé	Article nr. Artikel Nr. N° Article															
	Torx 8	001-3															
001-4	Screw for standard tool holder Schraube für Standard-Werkzeughalter Vis pour porte-outil standard	Article nr. Artikel Nr. N° Article															
	M3,5 x 7,5	001-4															

Coating of inserts

Beschichtung der Wendepatten

Revêtement des plaquettes

✓ = Available
✓ = Verfügbar
✓ = Disponible

Designation Bezeichnung Désignation	Description Beschreibung Description
K10	<p>Without coating K10 carbide</p> <p>Ohne Beschichtung K10 Hartmetall</p> <p>Sans revêtement Carbure K10</p>
BI40	<p>AlTi(C)N-based</p> <ul style="list-style-type: none"> • Universal coating. • High hardness. • Very smooth surface finish. • Suitable for steel and stainless steel. <p>AlTi(C)N-Basis</p> <ul style="list-style-type: none"> • Universalbeschichtung. • Hohe Schichthärte. • Sehr glatte Oberfläche. • Geeignet für Stahl und Edelstahl. <p>Base AlTi(C)N</p> <ul style="list-style-type: none"> • Revêtement universel. • Dureté élevée. • Bon glissement du copeau. • Adapté à l'acier et à l'acier inox.



Represented by Vertretet durch Représenté par

