







Hydraulic connectors Hydraulikanschlüsse Raccords hydrauliques



Standard hydraulic connectors
Standard-Hydraulikanschlüsse
Raccords hydrauliques standards

High pressure up to
Hochdruck bis
Haute pression jusqu'à

150 bar

	Description Bezeichnung Description	Article nr. Artikel Nr. N° Article
	High pressure tube 100 mm, G1/8" Hochdruckrohr 100 mm, G1/8" Tuyau haute pression 100 mm, G1/8"	01.04.4295
	High pressure tube 180 mm, G1/8" Hochdruckrohr 180 mm, G1/8" Tuyau haute pression 180 mm, G1/8"	01.04.4000
	High pressure tube 300 mm, G1/8" Hochdruckrohr 300 mm, G1/8" Tuyau haute pression 300 mm, G1/8"	01.04.3870
	High pressure tube 400 mm, G1/8" Hochdruckrohr 400 mm, G1/8" Tuyau haute pression 400 mm, G1/8"	01.04.4302
	Straight connector G1/8" Gerade Verbindung G1/8" Raccord droit G1/8"	01.04.2292
	Angled connector G1/8" Winkelstecker G1/8" Raccord coudé G1/8"	01.04.3340
	Straight connector M8x1 Gerade Verbindung M8x1 Raccord droit M8x1	01.04.3939
	Angled connector M8x1 Winkelstecker M8x1 Raccord coudé M8x1	01.04.3340.1

"RH" type hydraulic connectors
Hydraulikanschlüsse Typ "RH"
Raccords hydrauliques de type "RH"

High pressure up to
Hochdruck bis
Haute pression jusqu'à

250 bar

Hose with metal weave: highly abrasion resistant
Schlauch mit Metall-Ummantelung: sehr abriebfest
Tuyau avec tissage métallique: très résistant à l'abrasion



Quick change coupling: no key required
Schnellwechsellkupplung: kein Schraubenschlüssel erforderlich
Raccord à changement rapide: pas besoin de clé

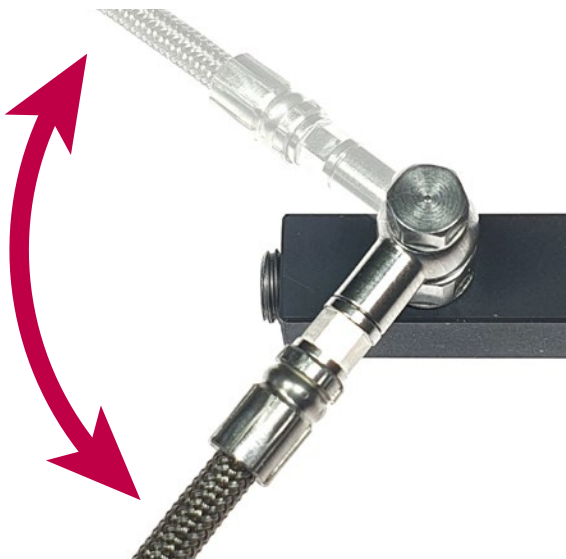
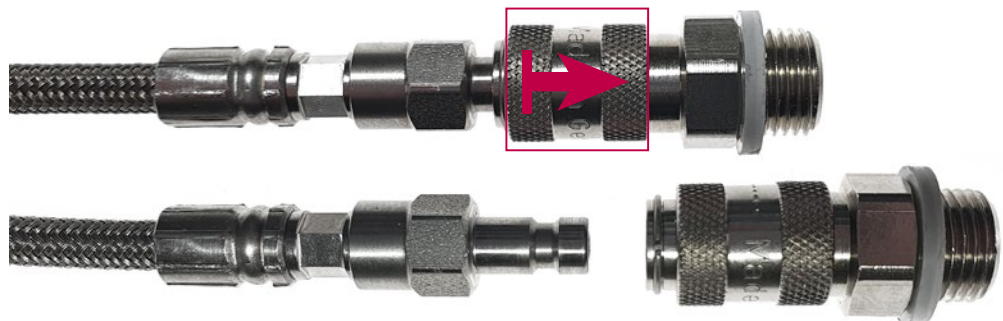

Swivel joint: easy connection of tools
Drehgelenk: einfacher Anschluss von Werkzeugen
Raccord orientable: connection facilitée des outils

	Description Bezeichnung Description	Article nr. Artikel Nr. N° Article
	Distributor with 1 input G1/4" and 4 outputs G1/8" Verteilerblock mit 1 Eingang G1/4" und 4 Ausgänge G1/8" Distributeur avec 1 entrée G1/4" et 4 sorties G1/8"	02.01.0041
	Banjo screw, external threading M5x0,5 Hohlschraube, Aussengewinde M5x0,5 Vis banjo, filet extérieur M5x0,5	RH22-40050530
	Banjo screw, external threading M5 Hohlschraube, Aussengewinde M5 Vis banjo, filet extérieur M5	RH22-40050830
	« Ringfitting », internal threading M5x0,5 « Ringfitting », Innengewinde M5x0,5 « Ringfitting », filetage intérieur M5x0,5	RH24-3250030
	90° angle connector, internal threading M5x0,5, external threading M5 90° Winkelanschluss, Innengewinde M5x0,5, Aussengewinde M5 Raccord coudé à 90°, filetage intérieur M5x0,5, filetage extérieur M5	RH23-3908530
	90° angle connector, internal threading M5x0,5, external threading M5x0,5 90° Winkelanschluss, Innengewinde M5x0,5, Aussengewinde M5x0,5 Raccord coudé à 90°, filetage intérieur M5x0,5, filetage extérieur M5x0,5	RH23-3908830
	« Stahlflex » high pressure hose, length 80 mm, external threading M5x0,5 « Stahlflex » Hochdruckschlauch, Länge 80 mm, Aussengewinde M5x0,5 Tube haute pression « Stahlflex », longueur 80 mm, filetage extérieur M5x0,5	RH28-3008030
	« Stahlflex » high pressure hose, length 100 mm, external threading M5x0,5 « Stahlflex » Hochdruckschlauch, Länge 100 mm, Aussengewinde M5x0,5 Tube haute pression « Stahlflex », longueur 100 mm, filetage extérieur M5x0,5	RH28-3010030

	Description Bezeichnung Description	Article nr. Artikel Nr. N° Article
	«Stahlflex» high pressure hose, length 180 mm, external threading M5x0,5 «Stahlflex» Hochdruckschlauch, Länge 180 mm, Aussengewinde M5x0,5 Tube haute pression «Stahlflex», longueur 180 mm, filetage extérieur M5x0,5	RH28-3018030
	Coupling plug, internal threading M5x0,5 Kupplung-Stecker, Innengewinde M5x0,5 Fiche de couplage, filetage intérieur M5x0,5	RH804012330
	Quick coupling, external threading G1/8". △ High pressure only up to 150 bar Schnellverschlusskupplung, Aussengewinde G1/8" △ Hochdruck nur bis 150 bar Raccord rapide, filet extérieur G1/8" △ Haute pression uniquement jusqu'à 150 bar	RH816180100
	Adaptor, external threading M8x1, internal threading M5x0,5 Adapter, Aussengewinde M8x1, Innengewinde M5x0,5 Adaptateur, filetage extérieur M8x1, filetage intérieur M5x0,5	RH54-358000030
	Adaptor, external threading G1/8", internal threading M8x1 Adapter, Aussengewinde G1/8", Innengewinde M8x1 Adaptateur, filetage extérieur G1/8", filetage intérieur M8x1	RH101980
	Reduction for hydraulic connector from G1/4" to G1/8" Hydraulik Reduzierung von G1/4" auf G1/8" Réduction hydraulique de G1/4" à G1/8"	RED G1/4" - G1/8"
	Double connector IT M5X0,5 Kupplung Doppelnippel IGF M5x0,5 Raccord double FI M5X0,5	RH25-396030

Examples of possible set-ups
Beispiele für mögliche Verbindungen
Exemples de montages possibles

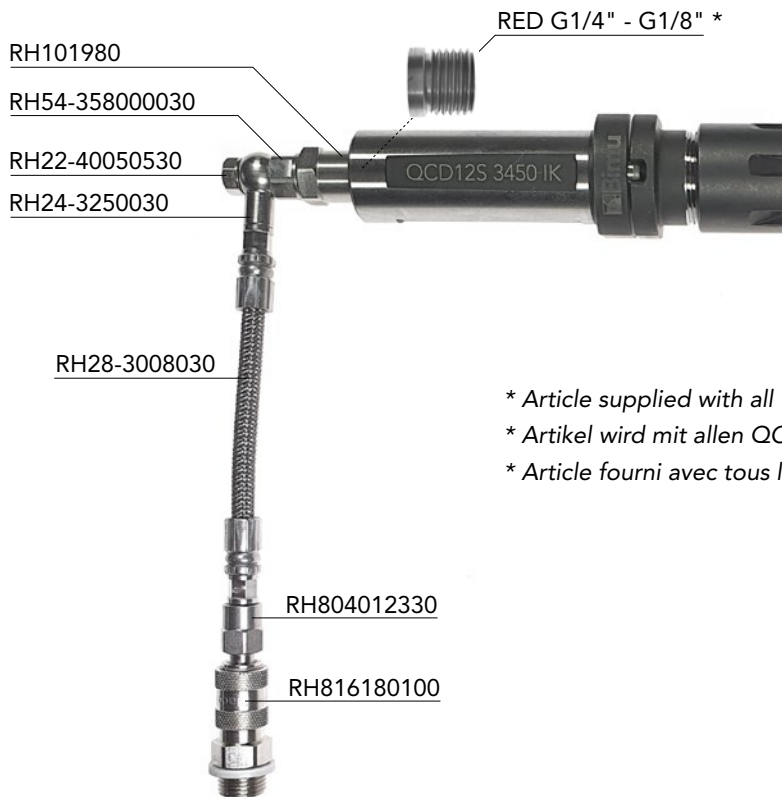
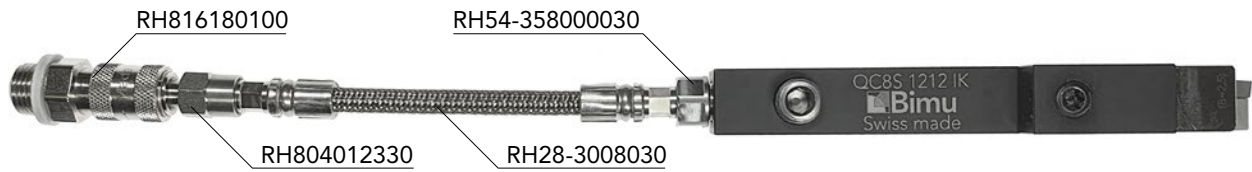

* Article supplied with all QCD tool holders
* Artikel wird mit allen QCD-Werkzeughaltern geliefert
* Article fourni avec tous les porte-outils de type QCD

Examples of possible set-ups
Beispiele für mögliche Verbindungen
Exemples de montages possibles





Represented by Vertreten durch Représenté par

