

800 line

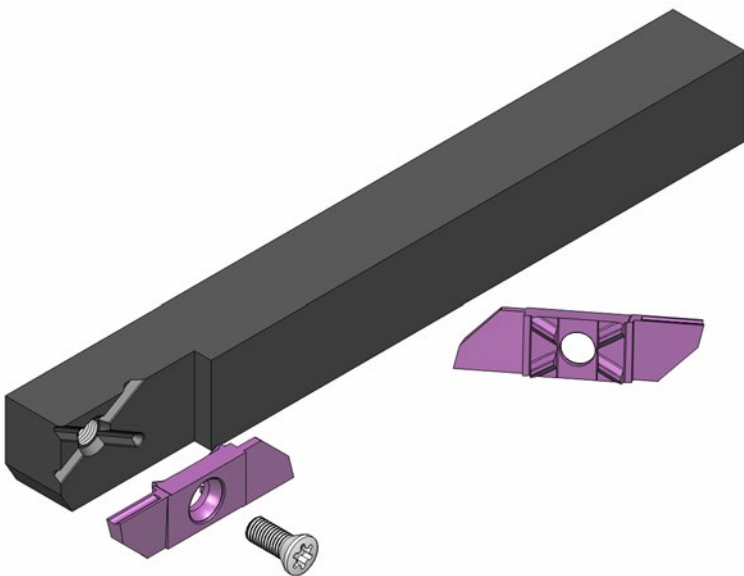

800

Inserts for 10x10, 12x12, 16x16 mm section tool holders.

Wendeplatten für Werkzeughalter mit Querschnitt 10x10, 12x12, 16x16 mm.

Plaquettes pour porte-outils de section 10x10, 12x12, 16x16 mm.

→ Ø 18 mm

800-8

Cut off inserts (height 7,9 mm) only for 8x8 mm section tool holders.

Abstechplatten (Höhe 7,9 mm) nur für Werkzeughalter mit Querschnitt 8x8 mm.

Plaquettes de tronçonnage (hauteur 7,9 mm) uniquement pour porte-outils de section 8x8 mm.

→ Ø 12 mm

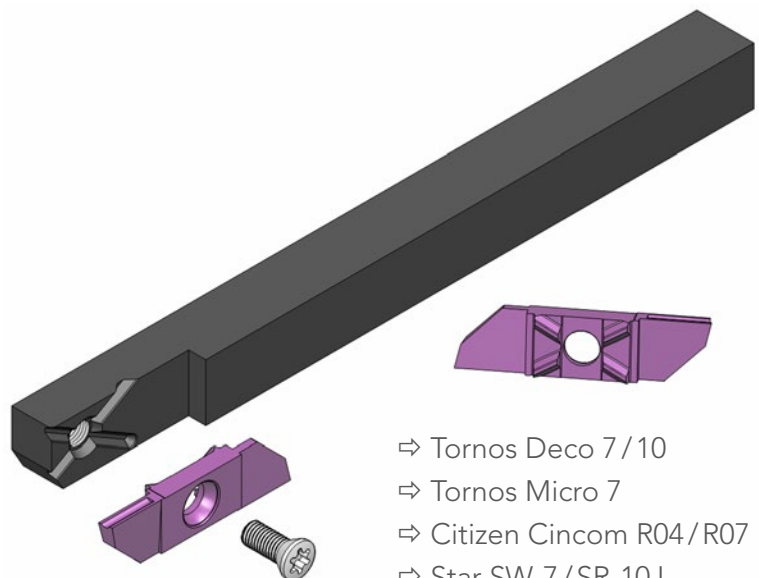

- ⇒ Tornos Deco 7 / 10
- ⇒ Tornos Micro 7
- ⇒ Citizen Cincom R04 / R07
- ⇒ Star SW-7 / SR-10J

Presentation of 800 line
Vorstellung der 800 line
Présentation de la 800 line

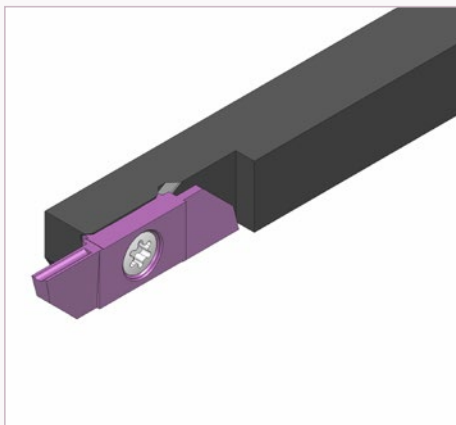
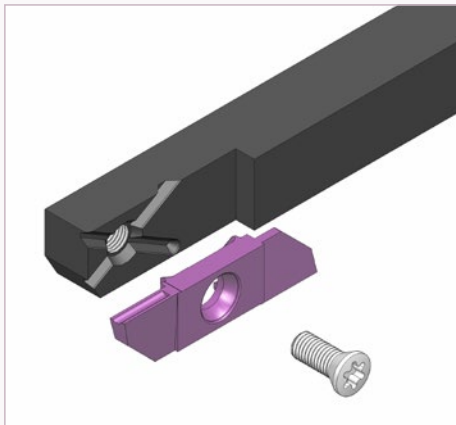
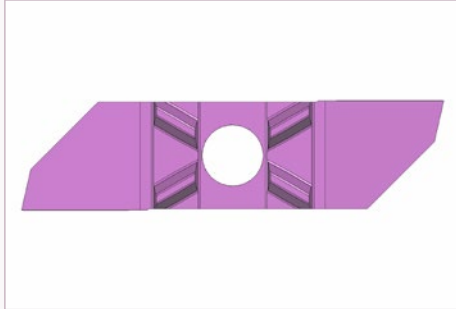

Advantages of 800 line

- X-Centering technology :
 - Repetitiveness of the cutting edge $\pm 0,01$ mm.
 - Positioning in all axes.
 - Insert turning without having to remove the screw.
 - The screw is free of all radial stress.
- 2 cutting edges available.

Vorteile der 800 line

- X-Centering Technologie.
 - Wiederholgenauigkeit der Schneidkante $\pm 0,01$ mm.
 - Positionierung in allen Achsen.
 - Wenden der Wendeplatte ohne Entfernen der Schraube.
 - Keine radialen Spannungen.
- 2 verfügbare Schneidkanten.

Avantages de la ligne 800 line

- Technologie X-Centering.
 - Répétitivité de l'arête de coupe $\pm 0,01$ mm.
 - Positionnement dans tous les axes.
 - Retournement de la plaquette sans enlever la vis.
 - La vis est libre de toute tension radiale.
- 2 arêtes de coupe.

Coating of inserts

Beschichtung der Wendepplatten

Revêtement des plaquettes

✓ = Available
 ✓ = Verfügbar
 ✓ = Disponible

Designation Bezeichnung Désignation	Description Beschreibung Description
K20	<p>Without coating K20 carbide</p> <p>Ohne Beschichtung K20 Hartmetall</p> <p>Sans revêtement Carbure K20</p>
BI40	<p>AlTi(C)N-based</p> <ul style="list-style-type: none"> • Universal coating. • High hardness. • Very smooth surface finish. • Suitable for steel and stainless steel. <p>AlTi(C)N-Basis</p> <ul style="list-style-type: none"> • Universalbeschichtung. • Hohe Schichthärte. • Sehr glatte Oberfläche. • Geeignet für Stahl und Edelstahl. <p>Base AlTi(C)N</p> <ul style="list-style-type: none"> • Revêtement universel. • Dureté élevée. • Bon glissement du copeau. • Adapté à l'acier et à l'acier inox.
BI90	<p>AlTiN-based</p> <ul style="list-style-type: none"> • Universal coating. • Good oxidation resistance. • High heat resistance. • Suitable for steel and stainless steel. <p>AlTiN-Basis</p> <ul style="list-style-type: none"> • Universalbeschichtung. • Gute Oxidationsbeständigkeit. • Hohe Hitzebeständigkeit. • Ideal für Stahl und Edelstahl. <p>BaseAlTiN</p> <ul style="list-style-type: none"> • Revêtement universel. • Bonne résistance à l'oxydation. • Haute résistance à la chaleur. • Adapté à l'acier et à l'acier inox.

Designation Bezeichnung Désignation	Description Beschreibung Description
TIN	TiN <ul style="list-style-type: none">• Universal coating. TiN <ul style="list-style-type: none">• Universalbeschichtung. TiN <ul style="list-style-type: none">• Revêtement universel.

Insert 800 : field of application
Wendepplatten 800 : Anwendungsbereiche
Plaquettes 800 : champ d'application

Maximum cutting-off
Maximaler Abstechdurchmesser
Tronçonnage maximum
Ø 18 mm

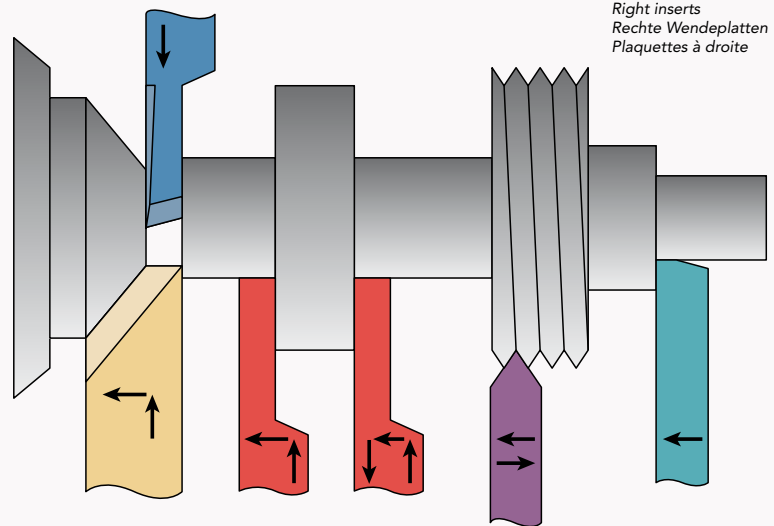

Right inserts
Rechte Wendepplatten
Plaquettes à droite

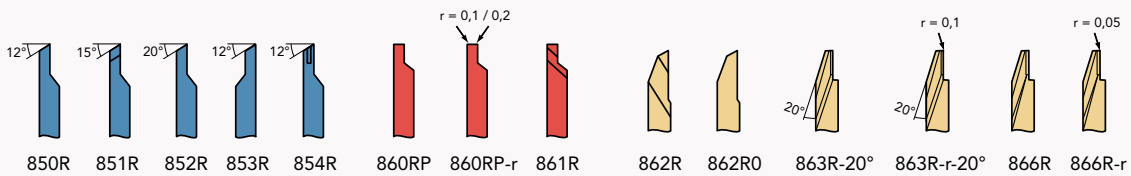

Cutting off
Abstechen
Tronçonnage

Plunging-Turning
Einstechen-Drehen
Fonçage-Tournage

Plunging-Turning
Einstechen-Drehen
Fonçage-Tournage

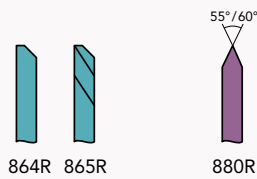

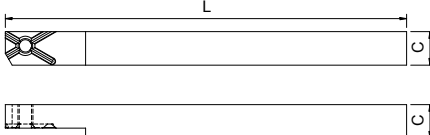

Turning
Drehen
Tournage

Threading
Gewindestrehlen
Filetage

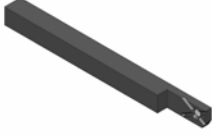
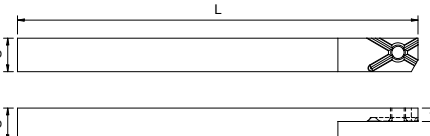
8xxR	Right tool holder Werkzeughalter rechts Porte-outil à droite	Section C Querschnitt C Section C	Length L Länge L Longueur L	Article nr. Artikel Nr. N° Article
		10 x 10	120	810R
		12 x 12	120	812R
		16 x 16	120	816R
		20 x 20	100	820R
		9,52 x 9,52 (3/8")	120	8952R
		12,7 x 12,7 (1/2")	120	8127R

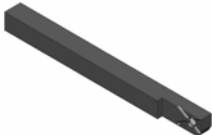
8xxR4	Right «Pick-up» tool holder «Pick-up» Werkzeughalter rechts Porte-outil «Pick-up» à droite	Section C Querschnitt C Section C	Length L Länge L Longueur L	Article nr. Artikel Nr. N° Article
		10 x 10	120	810R4
		12 x 12	120	812R4
		16 x 16	120	816R4
		9,52 x 9,52 (3/8")	120	8952R4
		12,7 x 12,7 (1/2")	120	8127R4
		<i>Use with 853R inserts Verwendung mit 853R Wendeplatten Utilisation avec les plaquettes 853R</i>		

8xxL	Left tool holder Werkzeughalter links Porte-outil à gauche	Section C Querschnitt C Section C	Length L Länge L Longueur L	Article nr. Artikel Nr. N° Article
		10 x 10	120	810L
		12 x 12	120	812L
		16 x 16	120	816L
		20 x 20	100	820L
		12,7 x 12,7 (1/2")	120	8127L

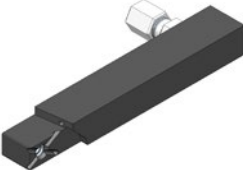
Tool holders with internal coolant Werkzeughalter mit Innenkühlung Porte-outils avec arrosage intégré				
	<i>See the «Tool holders with internal coolant» documentation for further information. Siehe die «Werkzeughalter mit Innenkühlung» Dokumentation für weitere Informationen. Voir la documentation «Porte-outils avec arrosage intégré» pour plus d'informations.</i>			

100-1	Key Schlüssel Clé	Article nr. Artikel Nr. N° Article
	Torx 15	100-1

100-4	Screw for standard tool holder Schraube für Standard Werkzeughalter Vis pour porte-outil standard	Article nr. Artikel Nr. N° Article
	M4,5 x 10,5	100-4

Blank
 Rohling
 Ebauche

R : Right machining
 R : Rechte Bearbeitung
 R : Usinage à droite

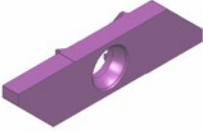
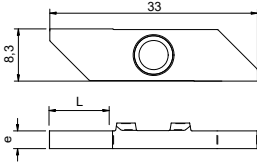
840R	Blank insert Rohling Wendepatte Plaquette ébauche	e	L	Article nr. Artikel Nr. N° Article		K20	B140	B190
		1,7	5,0	840R1,7		✓	✓	✓
		2,2	9,5	840R2,2		✓	✓	✓
		2,8	—	840R2,8		✓	✓	✓

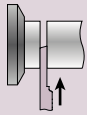

Guide bush cut off \varnothing 18 mm
 Abstechen an der Führungsbüchse \varnothing 18 mm
 Tronçonnage côté canon \varnothing 18 mm

R : Right machining
 R : Rechte Bearbeitung
 R : Usinage à droite

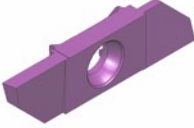
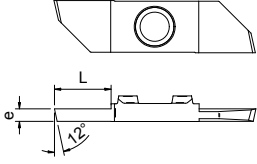
850R	Cutting insert 12° Abstechplatte 12° Tronçonneur 12°	e	L	Article nr. Artikel Nr. N° Article		B140	B190
		0,8	5,0	850R0,8		✓	✓
		1,0	5,0	850R1,0		✓	✓
		1,2	6,0	850R1,2		✓	✓
		1,5	7,5	850R1,5		✓	✓
		1,8	7,5	850R1,8		✓	
		2,0	9,0	850R2,0		✓	✓
		2,5	9,0	850R2,5		✓	✓

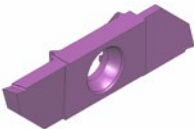
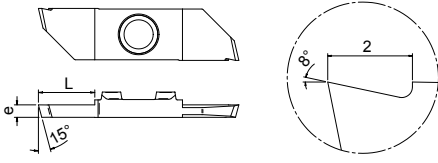
851R	Cutting insert 15° with chip breaker Abstechplatte 15° mit Spanbrecher Tronçonneur 15° avec brise-copeau	e	L	Article nr. Artikel Nr. N° Article		B140	B190
		1,5	7,5	851R1,5		✓	
		2,0	9,0	851R2,0		✓	✓

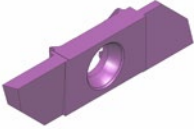
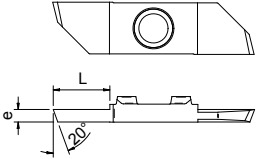
852R	Cutting insert 20° Abstechplatte 20° Tronçonneur 20°	e	L	Article nr. Artikel Nr. N° Article		B140	B190
		1,0	5,0	852R1,0		✓	✓
		1,2	6,0	852R1,2		✓	
		1,5	7,5	852R1,5		✓	✓
		2,0	9,0	852R2,0		✓	✓

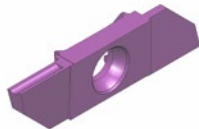
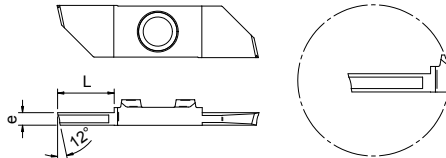
854R	Cutting insert with chip roller Abstechplatte mit Spanroller Tronçonneur avec roule-copeau	e	L	Article nr. Artikel Nr. N° Article	B140	B190
					✓	✓
		1,0	5,0	854R1,0	✓	✓
		1,2	6,0	854R1,2	✓	✓
		1,5	7,5	854R1,5	✓	✓
		2,0	10,0	854R2,0	✓	✓
		2,5	10,0	854R2,5	✓	✓

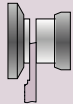
	Sub spindle cut off \varnothing 18 mm Abstechen an der Abgreifzange \varnothing 18 mm Tronçonnage côte prise de pièce \varnothing 18 mm	R : Right machining R : Rechte Bearbeitung R : Usinage à droite	
---	---	---	--

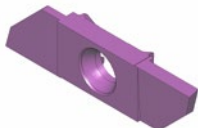
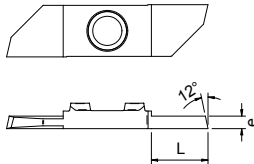
853R	Opposite cutting insert 12° Umgekehrte Abstechplatte 12° Tronçonneur inversé 12°	e	L	Article nr. Artikel Nr. N° Article	B140	B190
					✓	✓
		1,0	5,0	853R1,0	✓	✓
		1,2	6,0	853R1,2	✓	✓
		1,5	7,5	853R1,5	✓	✓
		2,0	9,0	853R2,0	✓	✓
		2,5	9,0	853R2,5	✓	✓

Use with 8xxL tool holders
Verwendung mit 8xxL Werkzeughalter
Utilisation avec les porte-outils 8xxL

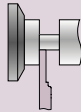
	Back turning Drehen hinten Tournage arrière	R : Right machining R : Rechte Bearbeitung R : Usinage à droite	
---	---	---	--

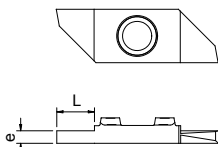
860RP	Back turning insert 0° Drehplatte hinten 0° Tourneur arrière 0°	e	L	Article nr. Artikel Nr. N° Article	B140	B190
					✓	✓
		0,8	3,0	860RP0,8	✓	✓
		1,0	4,0	860RP1,0	✓	✓
		1,2	4,0	860RP1,2	✓	✓
		1,5	5,0	860RP1,5	✓	✓
		2,0	5,0	860RP2,0	✓	✓
		2,5	5,0	860RP2,5	✓	✓

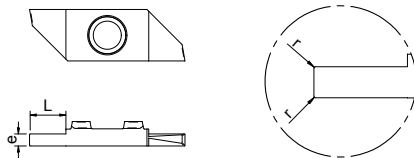
860RP - r	Back turning insert 0° with radii Drehplatte hinten 0° mit Radius Tourneur arrière 0° avec rayons	e	L	r	Article nr. Artikel Nr. N° Article	B140	B190
						✓	✓
		1,5	5	0,1	860RP1,5 - r 0,1 -	✓	✓
		1,5	5	0,2	860RP1,5 - r 0,2 -	✓	✓
		2,0	5	0,1	860RP2,0 - r 0,1 -	✓	✓
		2,0	5	0,2	860RP2,0 - r 0,2 -	✓	✓

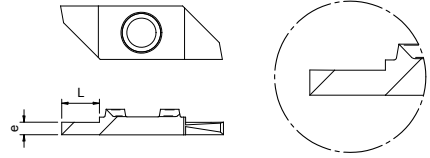
861R	Back turning insert with «parisian cut» Drehplatte hinten mit «Pariserschliff» Tourneur arrière avec «coupe parisienne»	e	L	Article nr. Artikel Nr. N° Article	BI40	BI90
				1,0	4,0	861R1,0
		1,2	4,0	861R1,2	✓	✓
		1,5	4,0	861R1,5	✓	✓
		1,8	6,0	861R1,8	✓	✓
		2,0	6,0	861R2,0	✓	✓
		2,5	6,0	861R2,5	✓	✓

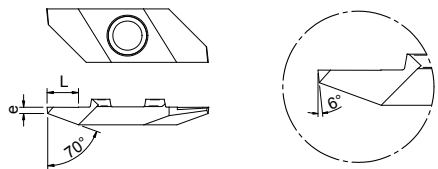
862R	Back turning insert with «parisian cut» Drehplatte hinten mit «Pariserschliff» Tourneur arrière avec «coupe parisienne»	e	L	Article nr. Artikel Nr. N° Article	BI40	BI90
				0,5	5,0	862R0,5
		1,0	5,0	862R1,0	✓	✓

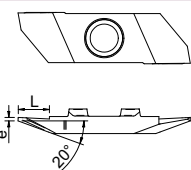
863R - 20°	Back turning insert 20° with chip roller Drehplatte hinten 20° mit Spanroller Tourneur arrière 20° avec roule-copeau	e	L	Article nr. Artikel Nr. N° Article	BI90
				0,6	5,0

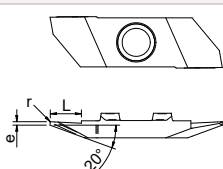
863R - r - 20°	Back turning insert 20° with chip roller and radius Drehplatte hinten 20° mit Spanroller und Radius Tourneur arrière 20° avec roule-copeau et rayon	e	L	r	Article nr. Artikel Nr. N° Article	BI90
				0,6	5,0	0,1

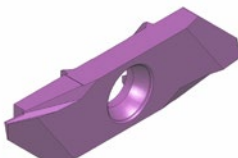
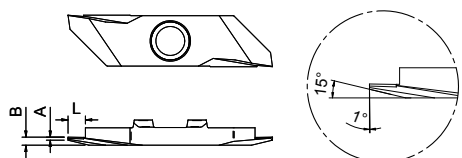
866R	Back turning insert with «W» chip roller Drehplatte hinten mit «W» Spanroller Tourneur arrière avec roule-copeau «W»	A	B	L	Article nr. Artikel Nr. N° Article	BI40	BI90	TiN
				0,5	1,3	2,5	866R2,5	✓

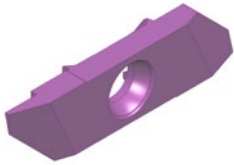
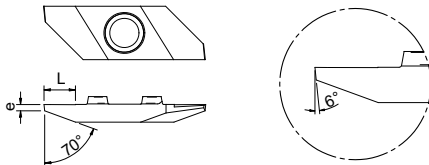
862RO	Back turning insert Drehplatte hinten Tourneur arrière			Article nr. Artikel Nr. N° Article	BI40
		e	L		
		0,5	5,0	862RO0,5	✓
		1,0	5,0	862RO1,0	✓

866R - r	Back turning insert with «W» chip roller and radius Drehplatte hinten mit «W» Spanroller und Radius Tourneur arrière avec roule-copeau «W» et rayon	A	B	L	r	Article nr. Artikel Nr. N° Article	BI40	TIN
		0,5	1,3	2,5	0,05			

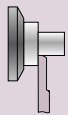

Front turning
Drehen vorne
Tournage avant

R : Right machining
R : Rechte Bearbeitung
R : Usinage à droite

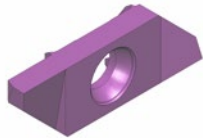
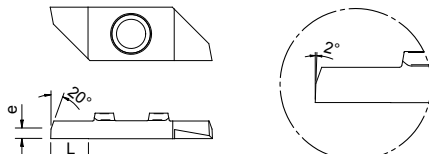
864R	Front turning insert Drehplatte vorne Tourneur avant			Article nr. Artikel Nr. N° Article	BI40	BI90
		e	L			
		1,5	6,0	864R	✓	✓

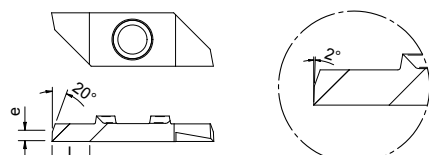
865R	Front turning insert with «parisian cut» Drehplatte vorne mit «Pariserschliff» Tourneur avant avec «coupe parisienne»			Article nr. Artikel Nr. N° Article	BI40	BI90
		e	L			
		1,5	6,0	865R	✓	✓

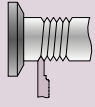

Threading
Gewindestrehlen
Filetage

R : Right machining
R : Rechte Bearbeitung
R : Usinage à droite

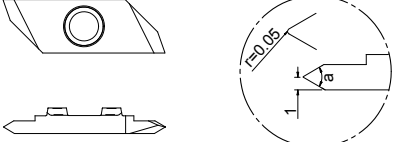
880R	Threading insert with partial profile Gewindeplatte mit Teilprofil Fileteur avec profil partiel	a	Article nr. Artikel Nr. N° Article	BI40	BI90
		55°	880R - 55° -	✓	✓
		60°	880R - 60° -	✓	✓

Blank
 Rohling
 Ebauche

L : Left machining
 L : Linke Bearbeitung
 L : Usinage à gauche

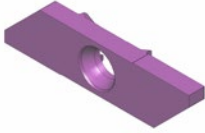
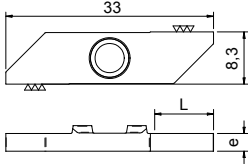
840L	Blank insert Rohling Plaque ébauche	e	L	Article nr. Artikel Nr. N° Article	K20	BI40	BI90
		1,7	5,0	840L1,7	✓	✓	✓
		2,2	9,5	840L2,2	✓	✓	✓
		2,8	—	840L2,8	✓	✓	✓

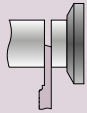

Guide bush cut off \varnothing 18 mm
 Abstechen an der Führungsbüchse \varnothing 18 mm
 Tronçonnage côté canon \varnothing 18 mm

L : Left machining
 L : Linke Bearbeitung
 L : Usinage à gauche

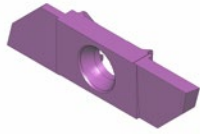
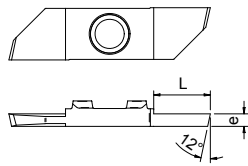

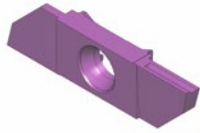
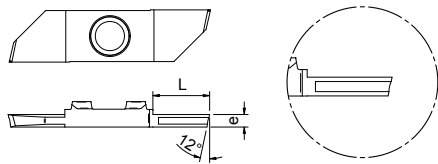
850L	Cutting insert 12° Abstechplatte 12° Tronçonneur 12°	e	L	Article nr. Artikel Nr. N° Article	BI40	BI90
		1,0	5,0	850L1,0	✓	✓
		1,2	6,0	850L1,2	✓	✓
		1,5	7,5	850L1,5	✓	✓
		2,0	9,0	850L2,0	✓	✓
		2,5	9,0	850L2,5	✓	✓

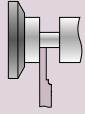
854L	Cutting insert with chip roller Abstechplatte mit Spanroller Tronçonneur avec roule-copeau	e	L	Article nr. Artikel Nr. N° Article	BI40	BI90
		1,0	5,0	854L1,0	✓	✓
		1,5	7,5	854L1,5	✓	✓
		2,0	10,0	854L2,0	✓	✓
		2,5	10,0	854L2,5	✓	✓

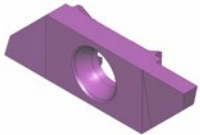
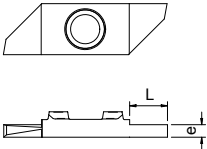
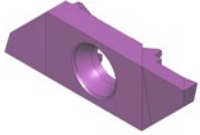
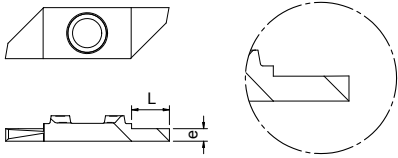

Back turning
 Drehen hinten
 Tournage arrière

L : Left machining
 L : Linke Bearbeitung
 L : Usinage à gauche

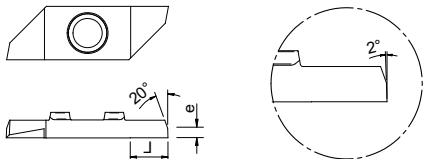
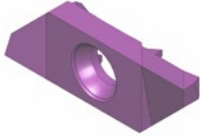
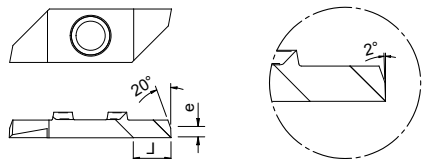
860LP	Back turning insert 0° Drehplatte hinten 0° Tournage arrière 0°	e L Article nr. Artikel Nr. N° Article	BI40																
		<table border="1"> <tr><td>1,0</td><td>4,0</td><td>860LP1,0</td></tr> <tr><td>1,5</td><td>5,0</td><td>860LP1,5</td></tr> <tr><td>2,0</td><td>5,0</td><td>860LP2,0</td></tr> <tr><td>2,5</td><td>5,0</td><td>860LP2,5</td></tr> </table>	1,0	4,0	860LP1,0	1,5	5,0	860LP1,5	2,0	5,0	860LP2,0	2,5	5,0	860LP2,5	<table border="1"> <tr><td>✓</td></tr> <tr><td>✓</td></tr> <tr><td>✓</td></tr> <tr><td>✓</td></tr> </table>	✓	✓	✓	✓
1,0	4,0	860LP1,0																	
1,5	5,0	860LP1,5																	
2,0	5,0	860LP2,0																	
2,5	5,0	860LP2,5																	
✓																			
✓																			
✓																			
✓																			
		<table border="1"> <tr><td>1,5</td><td>4,0</td><td>861L1,5</td></tr> <tr><td>2,0</td><td>6,0</td><td>861L2,0</td></tr> <tr><td>2,5</td><td>6,0</td><td>861L2,5</td></tr> </table>	1,5	4,0	861L1,5	2,0	6,0	861L2,0	2,5	6,0	861L2,5	<table border="1"> <tr><td>✓</td></tr> <tr><td>✓</td></tr> <tr><td>✓</td></tr> </table>	✓	✓	✓				
1,5	4,0	861L1,5																	
2,0	6,0	861L2,0																	
2,5	6,0	861L2,5																	
✓																			
✓																			
✓																			
		<table border="1"> <tr><td>1,5</td><td>6,0</td><td>864L</td></tr> </table>	1,5	6,0	864L	<table border="1"> <tr><td>✓</td><td>✓</td></tr> </table>	✓	✓											
1,5	6,0	864L																	
✓	✓																		
		<table border="1"> <tr><td>1,5</td><td>6,0</td><td>865L</td></tr> </table>	1,5	6,0	865L	<table border="1"> <tr><td>✓</td></tr> </table>	✓												
1,5	6,0	865L																	
✓																			

Inserts 800-8 : field of application

Wendepplatten 800-8 : Anwendungsbereiche

Plaquettes 800-8 : champ d'application

Maximum cutting-off
Maximaler Abstechedurchmesser
Tronçonnage maximum
Ø 12 mm

Right inserts
Rechte Wendepplatten
Plaquettes à droite

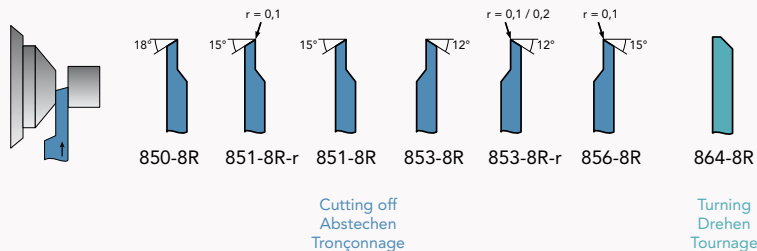

Left inserts
Linke Wendepplatten
Plaquettes à gauche

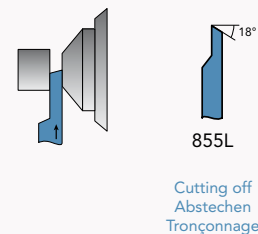

**Cutting of with 8x8 mm
tool holders !**

**Abstechen mit
Werkzeughalter 8x8 mm !**

**Tronçonnage avec des
porte-outils 8x8 mm !**

**Ideal for cutting on :
Ideal zum Abstechen auf :
Idéal pour tronçonnage sur :**

- Tornos Deco 7 / 10
- Tornos Micro 7
- Citizen Cincom R04 / R07
- Star SW-7
- Star SR-10J

**For cutting on cam
controlled machines.**







**Zum Abstechen auf
Kurvenautomaten.**

**Pour tronçonnage sur
machines à came.**

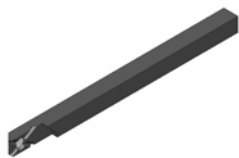
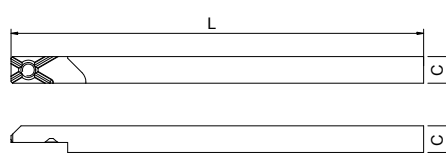
These inserts are 7,9 mm
high and only fit on 8x8 mm
tool holders.

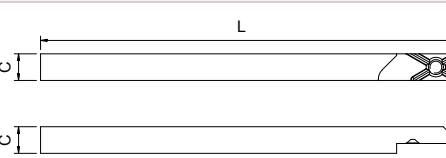
Diese Wendepplatten haben
eine Höhe von 7,9 mm und
können auf einem 8x8 mm
Halter aufgenommen
werden.

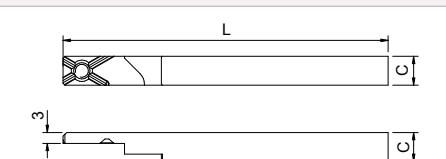
Ces plaquettes ont une
hauteur de 7,9 mm et se
montent uniquement sur
les porte-outils de section
8x8 mm.

808R 	Right tool holder Werkzeughalter rechts Porte-outil à droite 	Section C Querschnitt C Section C	Length L Länge L Longueur L	Article nr. Artikel Nr. N° Article 8 x 8 120 808R <i>Use with inserts 841R, 850-8 and 851-8R</i> <i>Verwendung mit Wendepplatten 841R, 850-8 und 851-8R</i> <i>Utilisation avec les plaquettes 841R, 850-8 et 851-8R</i>
808L 	Left tool holder Werkzeughalter links Porte-outil à gauche 	Section C Querschnitt C Section C	Length L Länge L Longueur L	Article nr. Artikel Nr. N° Article 8 x 8 120 808L <i>Use with inserts 841L, 855L, 853-8R and 856-8R</i> <i>Verwendung mit Wendepplatten 841L, 855L, 853-8R und 856-8R</i> <i>Utilisation avec les plaquettes 841L, 855L, 853-8R et 856-8R</i>
808L3 	Left tool holder Werkzeughalter links Porte-outil à gauche 	Section C Querschnitt C Section C	Length L Länge L Longueur L	Article nr. Artikel Nr. N° Article 8 x 8 90 808L3 <i>Use with inserts 850-8R</i> <i>Verwendung mit Wendepplatten 850-8R</i> <i>Utilisation avec les plaquettes 850-8R</i>
100-4c 	Screw for 8x8 mm tool holder Schraube für 8x8 mm Werkzeughalter Vis pour porte-outil 8x8 mm M4,5 x 7	Article nr. Artikel Nr. N° Article 100-4c		

Blank
 Rohling
 Ebauche

R : Right machining
 R : Rechte Bearbeitung
 R : Usinage à droite

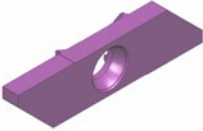
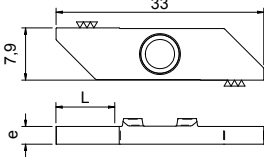
841R	Blank insert Rohling Plaquette ébauche	e	L	Article nr. Artikel Nr. N° Article	K20	B190
		2,2	9,5	841R2,2	✓	✓
		2,8	—	841R2,8	✓	✓

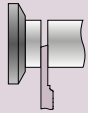

Guide bush cut off \varnothing 12 mm
 Abstechen an der Führungsbüchse \varnothing 12 mm
 Tronçonnage côté canon \varnothing 12 mm

R : Right machining
 R : Rechte Bearbeitung
 R : Usinage à droite

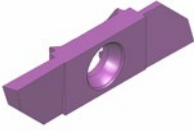
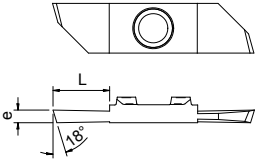
850-8R	Cutting insert 18° Abstechplatte 18° Tronçonneur 18°	e	L	Article nr. Artikel Nr. N° Article	B190
		1,0	5,0	850-8R1,0	✓
		1,2	6,0	850-8R1,2	✓
		1,5	7,0	850-8R1,5	✓
		2,0	8,0	850-8R2,0	✓

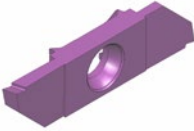
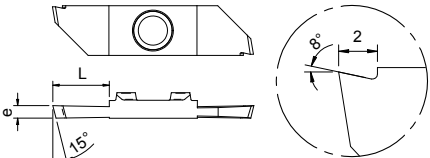
851-8R	Cutting insert 15° with chip breaker Abstechplatte 15° mit Spanbrecher Tronçonneur 15° avec brise-copeau	e	L	Article nr. Artikel Nr. N° Article	B190
		1,2	5,0	851-8R1,2	✓
		1,5	7,0	851-8R1,5	✓
		2,0	7,0	851-8R2,0	✓

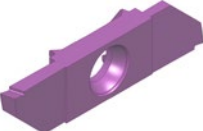
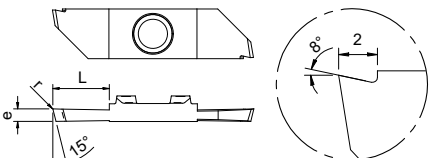
851-8R - r	Cutting insert 15° with chip breaker and radius Abstechplatte 15° mit Spanbrecher und Radius Tronçonneur 15° avec brise-copeau et rayon	e	L	r	Article nr. Artikel Nr. N° Article	B190
		1,2	6,0	0,1	851-8R1,2	✓
		1,5	7,0	0,1	851-8R1,5	✓

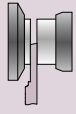

Sub spindle cut off \varnothing 12 mm
 Abstechen an der Abgreifzange \varnothing 12 mm
 Tronçonnage côte prise de pièce \varnothing 12 mm

R : Right machining
 R : Rechte Bearbeitung
 R : Usinage à droite

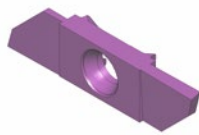
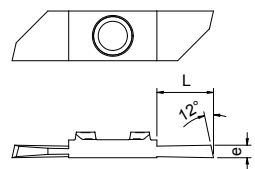
853-8R	Opposite cutting insert 12° Umgekehrte Abstechplatte 12° Tronçonneur inversé 12°	e	L	Article nr. Artikel Nr. N° Article	BI90
		1,2	6,0	853-8R1,2	✓
		1,5	7,0	853-8R1,5	✓
		2,0	8,0	853-8R2,0	✓
<p>Use with 808L tool holders Verwendung mit 808L Werkzeughalter Utilisation avec les porte-outils 808L</p>					

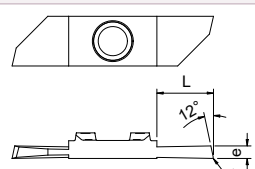
853-8R - r	Opposite cutting insert with radius Umgekehrte Abstechplatte mit Radius Tronçonneur inversé avec rayon	e	L	r	Article nr. Artikel Nr. N° Article	BI90
		1,5	7,0	0,1	853-8R1,5 - r 0,1 -	✓
		1,5	7,0	0,2	853-8R1,5 - r 0,2 -	✓
		2,0	8,0	0,1	853-8R2,0 - r 0,1 -	✓
<p>Use with 808L tool holders Verwendung mit 808L Werkzeughalter Utilisation avec les porte-outils 808L</p>						

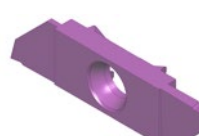
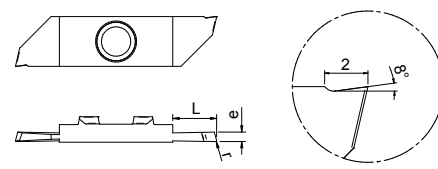
856-8R	Opposite cutting insert with chip breaker and radius Umgekehrte Abstechplatte mit Spanbrecher und Radius Tronçonneur inversé avec brise-copeau et rayon	e	L	r	Article nr. Artikel Nr. N° Article	BI90
		1,0	5,0	0,1	856-8R1,0 - r 0,1 -	✓
		1,2	5,0	0,1	856-8R1,2 - r 0,1 -	✓
		1,5	7,0	0,1	856-8R1,5 - r 0,1 -	✓
		2,0	7,0	0,1	856-8R2,0 - r 0,1 -	✓
		2,5	7,0	0,1	856-8R2,5 - r 0,1 -	✓
<p>Use with 808L tool holders Verwendung mit 808L Werkzeughalter Utilisation avec les porte-outils 808L</p>						

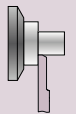

Front turning
 Drehen vorne
 Tournage avant

R : Right machining
 R : Rechte Bearbeitung
 R : Usinage à droite

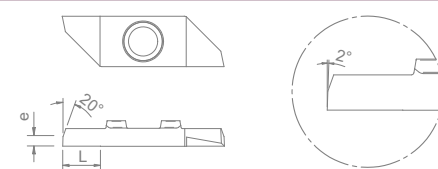
864-8R	Front turning insert Drehplatte vorne Tourneur avant	e	L	Article nr. Artikel Nr. N° Article	BI90
		1,5	6,0	864-8R	✓
<p>Use with 808R tool holders Verwendung mit 808R Werkzeughalter Utilisation avec les porte-outils 808R</p>					

Blank
 Rohling
 Ebauche

L : Left machining
 L : Linke Bearbeitung
 L : Usinage à gauche

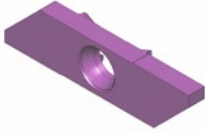
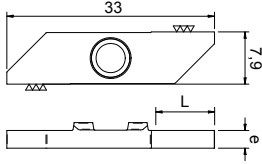
841L	Blank insert Rohling Plaquette ébauche			Article nr. Artikel Nr. N° Article	BI40	BI90
		e	L			
		1,7	5,0	841L1,7	✓	✓
		2,2	9,5	841L2,2	✓	✓
		2,8	—	841L2,8	✓	✓

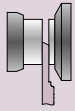

Guide bush cut off \varnothing 12 mm
 Abstechen an der Führungsbüchse \varnothing 12 mm
 Tronçonnage côté canon \varnothing 12 mm

L : Left machining
 L : Linke Bearbeitung
 L : Usinage à gauche

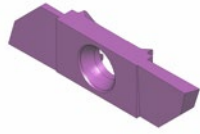
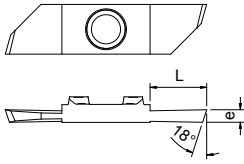
855L	Cutting insert 18° Abstechplatte 18° Tronçonneur 18°			Article nr. Artikel Nr. N° Article	BI40	BI90
		e	L			
		1,0	6,0	855L1,0	✓	
		1,2	6,0	855L1,2	✓	✓
		1,5	7,5	855L1,5	✓	✓
		1,8	7,5	855L1,8	✓	✓
		2,0	9,0	855L2,0	✓	✓



Represented by Vertreten durch Représenté par

